

This catalogue is under patent protection. Any unauthorized copying will be subject to legal liabilities. 版权所有 翻版必究

FASTENERS



**UNI-STAR
FASTENERS**

SHANGHAI UNI-STAR INDUSTRIAL & TRADING CO.,LTD.

Add: No.15-2, Hangqi Road, Damaiwan Industrial Park,
Pudong, Shanghai, China 201316

Tel:0086-21-31118588 31117922 31118532 31117936

Fax:0086-21-31118599

E-mail: market@unistar-tools.com

Http://www.unistar-tools.com



SHANGHAI UNI-STAR INDUSTRIAL & TRADING CO.,LTD.

上海天资星工贸有限公司



■ Shanghai Uni-Star Industrial & Trading Co., Ltd. is one of China's leading manufacturers & exporters of fasteners, such as Plastic Anchors, Metal Anchors, Screws, Nuts, with many years' experience in this Business. Most of our products are supplied to European & American markets, Some items in various packing are sold at hardware department store in developed countries. Moreover, we have established a long-term business relationship with some of well-established distributors of fasteners all over the world.

■ We own China's largest factory specializing in production of screws with 7000 square meters, where is about 1 hours' driving away from Shanghai, but also we operate other fastener factories, which specialize in production of Plastic Anchors near Shanghai. Our packing workshop is located in the suburb of Shanghai, with an area of 3000 square meters, where such operation as packing and inspection is completed.

■ So far, we have accumulated enough professional technique in products and experience, which make it possible for us to deliver quality products which is completely tested. UNI-STAR also realizes that specialized needs of its customers include not only premium products, but also a wide range of service, our team was developed in keeping with the company's mission to meet all our customer's needs. Quality products and quality service that's what UNIS-TAR is all about.

■ Choosing Uni-Star to work for the benefit of your business, for our unparalleled customer service, professional technique, competitive price, guaranteed quality, experienced staff, and great values. We're sure that Shanghai UNI-STAR will be your best partner in China if you're willing to go further with us.



CONTENT

Part One	Plastic Anchor	P1
Part Two	Metal Anchor	P7
Part Three	Screws	P17
Part Four	Nuts & Bolts & Washers	P22
Part Five	Rigging Hardware	P25
Part Six	Packages	P28
Part Seven	Quality Control	P30



■ PA-801 Hammer Drive anchor

- Material: Nylon/PE plug, steel nail screw
- Plug head type: Countersunk head, Cylinder head, mushroom head
- Screw head type: Countersunk Head / with shoulder

Anchor (Size)	Nail Screw (mm)	Anchor (Size)	Nail Screw (mm)
5X25	3.5X30	6X80	4X85
5X30	3.5X35	6X100	4X105
5X35	3.5X40	8X45	5X50
5X40	3.5X45	8X60	5X65
5X45	3.5X50	8X80	5X85
5X50	3.5X55	8X100	5X105
6X30	4X35	8X120	5X125
6X35	4X40	8X135	5X140
6X40	4X45	8X160	5X165
6X45	4X50	10X80	6X85
6X50	4X55	10X100	6X105
6X55	4X60	10X120	6X125
6X60	4X65	10X135	6X140
6X70	4X75	10X160	6X165



■ PA-802 Hammer Anchor with Two Wings

- Material: Nylon/PE plug and steel nail screw
- Plug head type: Countersunk head, flat head, truss head
- Screw head type: Countersunk Head, hex head, torx Countersunk head

Anchor (Size)	Nail Screw (mm)	Anchor (Size)	Nail Screw (mm)
6X35	4.5X40	8X100	5.5X105
6X40	4.5X45	8X120	5.5X125
6X50	4.5X55	8X135	5.5X140
6X60	4.5X65	10X60	7X65
6X80	4.5X85	10X80	7X85
8X40	5.5X45	10X100	7X105
8X50	5.5X55	10X115	7X120
8X60	5.5X65	10X135	7X140
8X80	5.5X85	10X160	7X165

■ PA-803 Nylon Hammer Anchor with Four Wings

- Material: Nylon
- Head type: Countersunk head
- Size: 14x100mm, 14x140mm



■ PA-804 Hammer Anchor with Six Wings

- Material.: Nylon/PE plug and steel nail screw
- Plug head type: Countersunk head, flat head, truss head
- Screw head type: Countersunk Head, hex head, torx Countersunk head

Anchor (Size)	Nail Screw (mm)	Anchor (Size)	Nail Screw (mm)
8X80	5.5X85	10X115	7X120
8X100	5.5X105	10X135	7X140
8X120	5.5X125	10X160	7X165
10X80	7X85	10X200	7X205
10X100	7X105	-	-



■ PA-805 Nylon Nail Anchors(Italian Type)

- Material.: Nylon plug, steel nail screw
- Plug head type: Countersunk head, mushroom head
- Screw head type: Countersunk Head, Pan Head

Anchor (Size)	Nail Screw (mm)	Anchor (Size)	Nail Screw (mm)
6X25	4X30	6X40	4X45
6X30	4X35	6X50	4X55
6X35	4X40	6X60	4X65





PA-806

■ PA-806 Nylon Nail Anchors(Australian Type)

- Material.: nylon plug, steel nail screw
- Plug head type: Countersunk head, mushroom head
- Screw head type: Countersunk Head, Pan Head

Anchor (Size)	Nail Screw (mm)	Anchor (Size)	Nail Screw (mm)
5.0x25	3x25	6.5x40	3x38
5.0x40	3x38	6.5x50	3x50
6.5x25	3x25	6.5x75	3x75



PA-807

■ PA-807 Nylon Frame Anchor

- Material.: Nylon plug and steel wood screw
- Cap colors: white, dark brown, and gray

Anchor (Size)	Nail Screw (mm)	Anchor (Size)	Nail Screw (mm)
8X75	5X85	10X75	6X85
8X100	5X110	10X100	6X110
8X120	5X130	10X120	6X130
8X140	5X150	10X140	6X150
-	-	10X160	6X170



PA-808

■ PA-808 Knot expansion pipe with/without rim

- Material.: Nylon/PE
- Color: Different colors available.
- Apply to solid and hollow walls.

Anchor Size	Drill	Nail Screw
M6x36	6	3-3.2mm
M8x50	8	3.5-4mm
M10x60	10	5-5.5mm
M12x70	12	6-8mm
M14x75	14	8-10mm

■ PA-809 Plastic Wall Anchor with/without rim

- Material.: Nylon & PE
- Ideal to be used for building materials, even thin.
- Good at electric insulation, tensibility, and high pressure.
- Structure designed with gear can prevent itself sliding in the hole.
- Special quantity packing available.

Anchor Size	Drill	Nail Screw (mm)
4x20	4	2-2.5
5x25	5	2.5-4
6x30	6	3.5-5
7x35	7	4.0-5
8x40	8	4.5-6
10x50	10	6.0-8
12x60	12	8.0-10
14x75	14	10.0-12
16x80	16	12.0-14

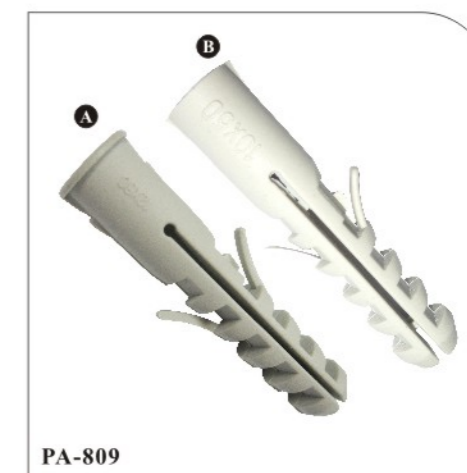

PA-809

■ PA-810 Plastic Toggle Anchor

- Material.: Nylon & Polypropylene
- Used by removing the outer wings in solid base materials.
- Special quantity packing available.

- A Size: 3-6mm, 9-13mm, 16-19mm
- B Size: 4-12mm, 15-19mm, 24-28mm



PA-810

■ PA-811 Nylon Easy Drive Anchor

- Material.: Nylon

- A With Three Points On Top
Size.: 13x42mm, 14x28mm
- B With One Point On Top
Size: 13x40mm, 14x32mm
- C Size: 14x22mm
- D Size: 8x30mm, 10x50mm



PA-811



PA-812

■ PA-812 Plastic Wall Plug

- Material.: polyethylene
- Available in various colors.
- Sizes: 4-8x7/8, 8-10x1, 10-12x5/4, 12-12x7/4, 12-16x3/2
- Designed for use with lightweight fixtures
- Used in concrete, block, brick and wallboard.

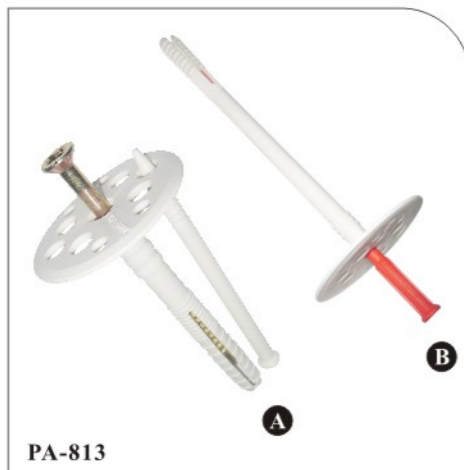

PA-813

■ PA-813 Plastic Anchor with Disc and Nail Screw

- Material.: Nylon plug and steel nail screw
- The disc can fix bigger surface.

Anchor Size	Drill	Nail Screw (mm)
M8x50	8	4.8-5
M8x60	8	4.8-5
M8x80	8	4.8-5
M8x100	8	4.8-5
M8x120	8	4.8-5
M8x135	8	4.8-5



PA-814

■ PA-814 Nylon Hollow Expansion Pipe

- Material.: Nylon
- Apply to solid and hollow walls
- Special quantity packing available

Anchor Size	Drill	Nail Screw (mm)
M6x35	6	3-3.5
M8x50	8	4-4.5
M10x60	10	5.0-6

■ PA-815 Nylon Expansion pipe

- Material.: Plastic
- Different sizes available.
- Apply to solid and hollow walls.
- Special quantity packing available.



PA-815

■ PA-816 Nylon Slight Sleeve Anchor

- Material.: Steel steel screws and nylon plug
- For fixing of concrete, solid bricks, perforated bricks, hollow blocks
- Special quantity packing available.

Anchor Size	Drill	Nail Screw (mm)
M4x42	9x39	9
M5x46	12x43	12



PA-816

■ PA-817 Plastic Expansion Pipe

- Material.: Plastic
- Different colors and sizes are available.
- Used in concrete, block, brick and wallboard.
- Special quantity available.



PA-817

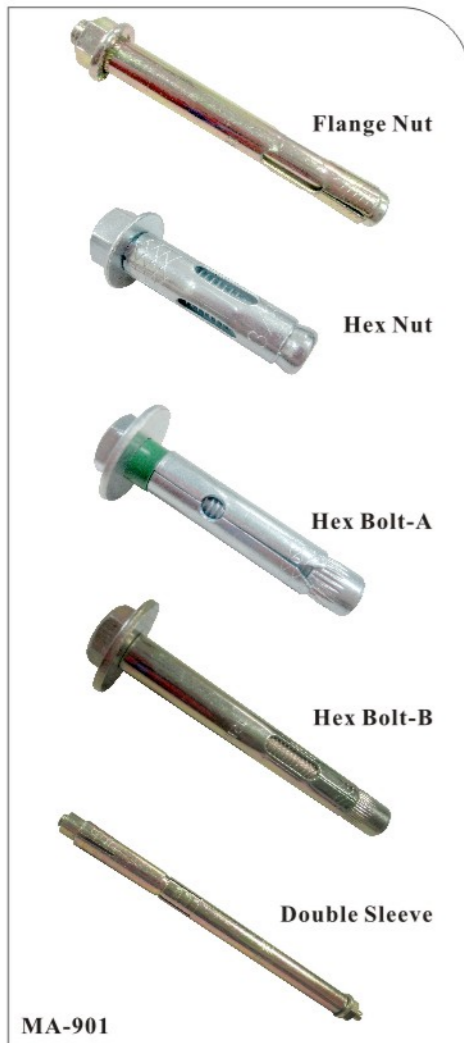

■ MA-901 Sleeve Anchor

- Material: Carbon steel, stainless steel
- Surface: Yellow or white zinc plated, hot dipper galvanized (with A2 clip) or mechanical galvanized (with A2 clip) are available.
- Size: M6, M8, M10, M12, M16, M20
1/4", 5/16", 3/8", 1/2", 5/8", 3/4"

HOOK BOLT



■ MA-902 Metal Frame Anchor

- Material: Carbon steel, zinc plated
- Galvanized steel sleeve fitting with machine screw and colors cap.

Size	Anchor/Hole Dia (mm)	Min Hole Depth (mm)	Size	Anchor/Hole Dia (mm)	Min Hole Depth (mm)
8x72	8	50	10x92	10	50
8x92	8	50	10x112	10	50
8x112	8	50	10x132	10	50
8x132	8	50	10x152	10	50
8x152	8	50	10x182	10	50
8x172	8	50	10x202	10	50
10x72	10	50	10x232	10	50

■ MA-903 Hollow Wall Anchor

- Material: Carbon steel, zinc plated
- Securely fasten mirrors, pictures, cabinets, curtain-drapes-shelf brackets, bathroom fixtures to hollow walls of plaster over wood lath or metal lath, wallboard, gypsum or cinder block, hollow tile, etc.
- Fixtures can be removed or replaced for redecorating without disturbing the Hollow Wall Anchors.
- Anchors with O-hook, C-hook, L-hook also available.
- Body shells can be supplied separately.

Size (mm)	Drill Φ	Screw Length (mm)	Size (mm)	Drill Φ	Screw Length (mm)
M4x21	8	28	M5x80	9	83
M4x32	8	40	M6x37	10	44
M4x38	8	46	M6x52	10	57
M4x46	8	53	M6x65	10	70
M4x46	8	53	M6x80	10	83
M4x54	8	59	M8x37	12	44
M4x59	8	66	M8x52	12	57
M5x37	9	44	M8x65	12	70
M5x52	9	57	M8x80	12	83
M5x65	9	70			

Hollow Wall Anchor in Drive Type(F)

Size (mm)	Drill Φ	Screw Length (mm)	Size (mm)	Drill Φ	Screw Length (mm)
M4x22	8	35	M4x46	8	60
M4x34	8	47	M4x46	8	80



■ MA-904 Wall Anchor Setting Tool

- Different types are available.
- A Size: 7"
- B Size: 8.5"



■ MA-905 Wedge Anchor

- Material: Steel and stainless steel
- Yellow zine plated,white zine plated,hot dipper galvanized(with A2 clip)or mechanical galvanized (with A2 clip) are available.
- Anchor can be hammered below the surface of the concrete when no longer needed.
- The one piece clip is formed around anchor, assuring full expansion for dependable, superior holding power. Expanding clip will not fall off or twist in the hole.
- Other sizes available: 1/4", 3/8", 1/2", 5/8",3/4", 7/8", 1", 1-1/4"



MA-905

Anchor Size	Anchor Length (mm)	Thread Length (mm)
M6	40-95	18-25
M8	50-220	25
M10	65-130	30
M12	80-150	40
M16	105-220	60
M20	125-300	65

■ MA-906 Chemical Anchor

- Material: Steel(4.8, 5.8, 8.8 grade).ss304,ss316
- Surfacefinish: Zinc.Plating. Host-Dip. Galvanized
- A: Hex Head
- B: Inner Socket
- Heavy duty fixing without radial influence of expansion forces can be used close to edges.
- Size: M6, M8, M10, M12, M16, M20, M24,M30
1/4", 3/8", 1/2", 5/8", 3/4", 7/8", 1", 1-1/4"

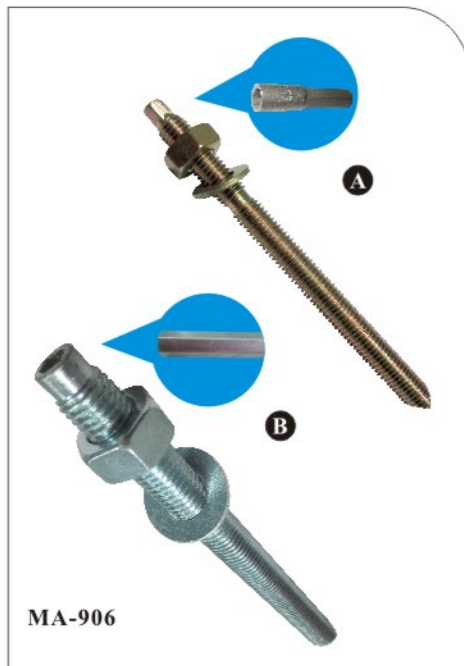

MA-906

■ MA-907 Drop In Anchor

- Material: Carbon steel(5.8 grade), zinc plated; ss304, ss316
- A safe working load should not exceed 25% of stated value.
- Other sizes available: 1/4", 3/8", 1/2", 5/8",3/4", 7/8", 1"

Size	Anchor/Hole Dia (mm)	Min Hole Depth (mm)	Size	Anchor/Hole Dia (mm)	Min Hole Depth (mm)
M6	8	25	M12	16	50
M8	10	30	M16	20	65
M10	12	40	M20	25	80



MA-907

■ MA-908 Brass Drop In Anchor

- Material: Brass
- Perfect expansion and specially designed built-in plug ensures full expansion of anchor.
- Other sizes available: 1/4", 3/8", 1/2",5/8"

Size (mm)	Drill Φ	Screw Length (mm)	Size (mm)	Drill Φ	Screw Length (mm)
M4	5	16	M10	12	32
M5	6.5	21	M12	15	41
M6	8	24	M14	18	43
M8	10	31	M16	20	45



MA-908

■ MA-909 Cut Anchor

- Material: Steel(4.8 grade) , stainless steel
- Improved expansion anchor with internal thread and a plug
- Other sizes available: 1/4", 3/8", 1/2", 5/8",3/4", 7/8"

Anchor Size (mm)	Anchor Dia. (mm)	Anchor Length (mm)	Thread Length (mm)	Bolt Thread Fit Length (mm)
M6	10.5	30	9	8
M8	12.0	35	12	10
M10	14.0	40	14	12
M12	17.5	52	20	16
M16	21.5	63	24	20
M20	25.5	83	31	25
M22	28.5	93	36	30



MA-909



MA-910

■ **MA-910**
Easy Drive Anchor

- Material: Zinc alloy (Zamak)
- **A** Size: 15x29 mm, 12.5x33mm
- **B** Size: 14x33 mm
- **C** Size: 12.5x30mm, 13x42mm

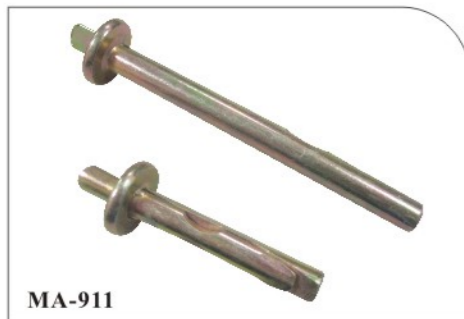

MA-911

■ **MA-911**
Ceiling Anchor

- Material: Concrete and Stone
- Material: Carbon steel
- Size.: 6x40 mm, 6x65 mm
- Yellow Zinc Plated, or White Zinc Plated



MA-912

■ **MA-912**
Christmas Tree Anchor

- Material: Carbon steel
- Size.: 5x30 mm, 6x32 mm, 8x38 mm, 8x60 mm, 10x60 mm
- Yellow Zinc Plated, or White Zinc Plated



MA-913

■ **MA-913**
Blind Rivet

- Material: Aluminium/Steel, Steel/Steel, Stainless
- Size: M3.2, M4.0, M4.8, M6.4 1/8", 5/32", 3/16", 1/4"
- Zinc Plated

■ **MA-914**
Spring Toggle

- Material: Steel
- Heavy gauge wings is high capacity truss design.
- For fixing to cavity walls and ceiling of low structural strength.
- Other screw heads and hook types available.
- Body shells can be supplied separately.

Size	Drill Dia. (mm)	Wing Length (mm)	Size	Drill Dia. (mm)	Wing Length (mm)
M3	10mm	34	M8	20mm	66
M4	12mm	39	M10	23mm	74
M5	14.5mm	50	M12	32mm	88
M6	16.5mm	53			



MA-914

■ **MA-915**
Gravity Toggle

- Material: Steel
- Heavy gauge wings is high capacity truss design.
- For fixing to cavity walls and ceiling of low structural strength.
- Other screw heads and hook types available.
- Body shells can be supplied separately.

Size	Length (mm)	Drill Hole (mm)	Size	Length (mm)	Drill Hole (mm)
M4	48	10	M6	85	16
M5	62	10	M8	125	20



MA-915

■ **MA-916**
Expansion Anchor

- Material: Zinc alloy

A Single

B Double

Size	Min Drill Dia.	Hole Depth
1/4-20	1/2"	1-3/4
5/16-18	5/8"	1-5/8
3/8-16	3/4"	1-5/8
1/2-13	7/8"	2-1/2
5/8-11	1"	2-3/4
3/4-10	1-1/4"	3-7/8

Size	Min Drill Dia.	Hole Depth
1/4-20	1/2"	1-1/4
5/16-18	5/8"	1-1/2
3/8-16	3/4"	1-3/4
1/2-13	7/8"	2-1/2
5/8-11	1"	2-1/2
3/4-10	1-1/4"	3-1/2



MA-916



MA-917a

■ MA-917a Heavy Duty Shield Anchor with Segments

- Material: Steel
- High retaining power and can be removed easily.
- When tightening the nut or screw, the conical section is pulled into the anchor shells expanding it and wedging it inside the anchor base.
- Two segments, three segments, and four segments available.
- Body shells can be supplied separately.

Item NO.	Size (mm)	Drill Dia. (mm)
A/B/C	M6×40	10
	M8×50	14
	M10×60	16
	M12×80	20
	M16×105	25
	M20×130	32
D	M6×45	10
	M8×51	12
	M10×60	15
	M12×73	18



MA-917b

■ MA-917b Heavy Duty Shield Anchor

- Material: Steel
- High retaining power and can be removed easily.
- When tightening the nut or screw, the conical section is pulled into the anchor shells expanding it and wedging it inside the anchor base.
- Two segments, three segments, and four segments available.
- Other hooks also available.
- Body shells can be supplied separately.

Size	Drill Dia. (mm)	Anchor Length (mm)	Size	Drill Dia. (mm)	Anchor Length (mm)
M6	12	45	M12	20	75
M8	14	55	M16	25	115
M10	16	60	M20	32	130

■ MA-918 Steel Slight Sleeve Anchor

- Material: Steel
- For fixing of concrete, solid bricks, perforated bricks, hollow blocks.
- Any screw head available as your requirement.
- Pre-assembled for quick and easy installation.
- High holding power.
- Other hooks also available.
- Body shells can be supplied separately.
- Special quantity packing available.

Screw Size	Sleeve Size (mm)	Drill Φ
M4x42	8x34	8
M5x46	9x36	9

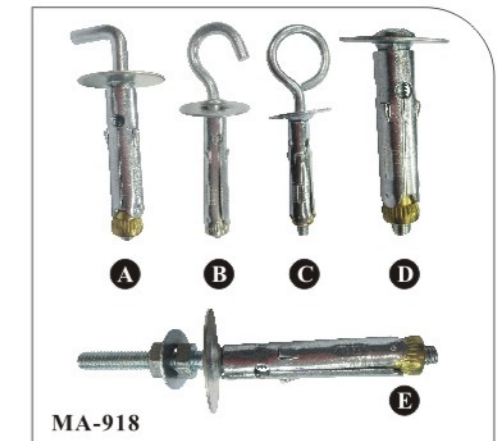

MA-918

■ MA-919 Machine Screw Anchor

- Material: Zinc alloy
- Can be used in all types of masonry from concrete to brick
- A safe working load should not exceed 25% of stated value.
- Size: 1/4", 3/8", 1/2", 5/8", 3/4", 7/8", 1", 1-1/4"



MA-919

■ MA-920 Hammer Drive Anchor

- Material: Body: Zinc alloy (Zamak); Nail: Carbon steel

Dia.	Length	Fastener Material Up to	Dia.	Length	Fastener Material Up to
3/16"	7/8"	1/4"	1/4"	3"	2-1/4"
1/4"	3/4"	3/16"	M5	20	6.5
1/4"	1"	1/4"	M6	30	12.5
1/4"	1-1/4"	1/2"	M6	40	20
1/4"	1-1/2"	3/4"	M6	50	30
1/4"	2"	1-1/4"	M6	65	45
1/4"	2-1/2"	1-3/4"			



MA-920



MA-921

■ MA-921 Tie Wire Anchor

- Material: Steel (4.8grade). ss304(A2)

Item No.	Size	Max. Thickness (mm)	Hole Size
A	M6	35	6mm
B	1/4	35	1/4"

■ MA-922 Hit Anchor

- Material: Carbon steel, zinc plated; stainless steel 304(A2)
- Installation condition can be adjusted from pin to nut.

Size	Thread Length (mm)	Drill Dia.	Size	Thread Length (mm)	Drill Dia.
M6x45	15	6.4	M12x60	20	12.7
M6x60	20	6.4	M12x70	25	12.7
M8x50	20	8.5	M12x90	30	12.7
M8x70	25	8.5	M12x100	40	12.7
M10x50	20	10.5	M12x120	50	12.7
M10x60	25	10.5	M16x100	40	17
M10x80	25	10.5	M16x120	40	17
M10x90	30	10.5	M16x150	50	17
M10x100	30	10.5	M20x130	50	21.5
M10x120	30	10.5	M20x150	50	21.5
			M20x190	50	21.5



MA-922

■ MA-923 Bolt Anchor

- Material: Steel(4.8 grade) , stainless steel 304(A2)
- Surface finish: Zinc plating, hot-dip
- Other sizes available: 1/4", 3/8", 1/2", 5/8", 3/4", 7/8", 1"

Size	Outside Dia. (Mm)	Sleeve Length (mm)	Size	Outside Dia. (Mm)	Sleeve Length (mm)
M6x50	9.5	30	M12x200	17.3	50
M8x65	12	35	M16x100	21.7	50
M8x70	12	35	M16x120	21.7	60
M10x70	14	40	M16x150	21.7	60
M10x80	14	40	M16x200	21.7	60
M10x100	14	40	M20x160	25.4	80
M10x120	14	40	M20x200	25.4	80
M12x100	17.3	50	M22x200	28.6	90
M12x120	17.3	50	M24x200	31.8	110
M12x150	17.3	50			



MA-923

■ MA-924 Eye Coupling Nuts

- Material: Steel and stainless steel
- The shank of eye coupling nut is made by Multi-station Former Cold Forging and the eye is pressed with flattening and piercing.
- Tapped inner hole is perpendicular and concentric with axis of shank within a tolerance of 0.044" and bearing face has a countersunk, flat end that made eye coupling nut easy fasten with Sleeve Anchor, Wedge Anchor and All Thread Rod, etc.

Size UNC	Shank Dia	Total Length	Hole Dia
1/4-20	5/16	1-1/2	1/4
5/8-18	3/8	1-7/8	5/16
3/8-16	1/2	2	3/8



MA-924

■ MA-925 Hammer Metal Plug

- Material: Carbon steel
- Surface: zinc plated
- Special size available.
- Use hammer to hit into plasterboard, then fix by screw.
- Easy to install.
- Special quantity packing available.



MA-925

■ MA-926 Express Nail Anchor

- Material: Steel
- Installed by hammer
- Punch at both end, in order to avoid concatenating together
- Special length are available

Size	Hole Dia (mm)	Min Hole Depth (mm)	Max Fixture Thickness (mm)
5x26	5	20	6
5x50	5	20	30
6x30	6	25	5
6x40	6	30	10
6x50	6	30	20
6x60	6	30	30
6x80	6	30	50
8x70	8	40	30
8x90	8	40	50
8x110	8	40	70
8x120	8	40	80
8x130	8	40	90
8x150	8	40	110
8x180	8	40	140



MA-926



■ **SD-101**
Drywall Screws

- Material.:Carbon steel, harden
- Surface: Black/ Gray phosphate, Zinc plated
- Flat Philips Bugle Head
- Size: M3.5-M4.8
6#, 7#, 8#, 10#
- Fine thread, coarse thread, hi-lo thread

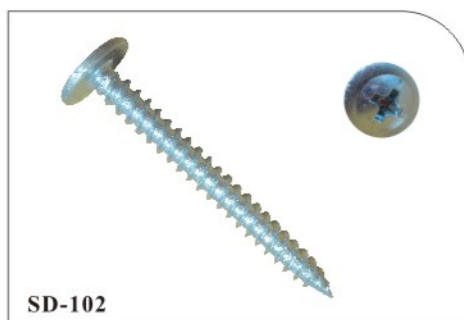

■ **SD-102**
**Wafer(modified truss)
Head Self-tapping Screw**

- Material.: Carbon steel C1022, harden
- Surface: Zinc plated
- Size: M3.5, M4.2
6#, 8#

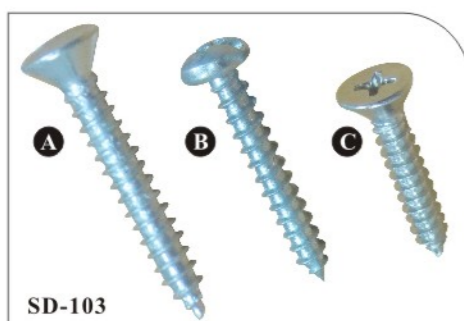

■ **SD-103**
DIN 7981,7982,7983 Self-tapping Screws

- Material.:Carbon steel C1022, stainless steel(A2,A4)
- Surface: Zinc plated
- Size: M2.2--M6.3
- Head Type:
DIN7981: Cross Pan Head
DIN7982: Cross Recessed Countersunk Flat Head
DIN7983: Phil Recessed Raised Countersunk Head
- Special type: with ribs or wings; with T-17 point

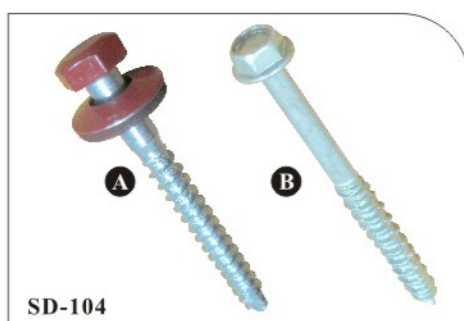

■ **SD-104**
Hexagon Flange Head Self Tapping Screws

- Material.:Carbon steel
- Surface: Zinc plated
- Standard: DIN6928
- with washer(plastic or EPDM) is available
- Special type: hi-low thread; with T-17 point
- Size: M4.8--M6.3

■ **SD-105**
Philips Pan Framing Self-tapping Screws

- Material.:carbon steel,harden
- Surface: Black/ Gray phosphate, Zinc plated
- with serrations is available.
- Size: M3.5x9.5, M3.5x11



■ **SD-106**
Bugle Head Self-drilling Screws

- Material.:Carbon Steel C1022
- Surface: Black/ Gray phosphate, Zinc plated
- Good drilling performance
- Various sizes are available



■ **SD-107**
**Wafer(modified truss)
Head Self-drilling Screw**

- Material.: Carbon steel C1022, harden
- Surface: Zinc plated
- Size: M3.5, M4.2
6#, 8#



■ **SD-108**
**DIN7504K, 7504P, 7504N Self-drilling
Screws**

- Material.:Carbon steel C1022, harden
- Surface: Zinc plated
- Size: M2.9--M6.3
- Head Type:
DIN7504K: Hex Washer Head
DIN7504P: Countersunk Flat Head
DIN7504N: Pan Head
- Special type is also available:
with ribs or wings; with T-17 point

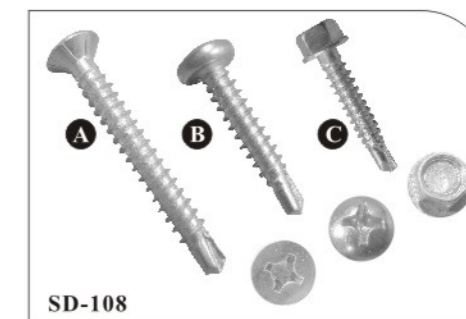



■ **SD-109**
Phillips Pan Framing Self-drilling Screws

- Material.:carbon steel,harden
- Surface: Black/ Gray phosphate, Zinc plated
- with serrations is available.
- Size: M3.5x9.5, M3.5x11

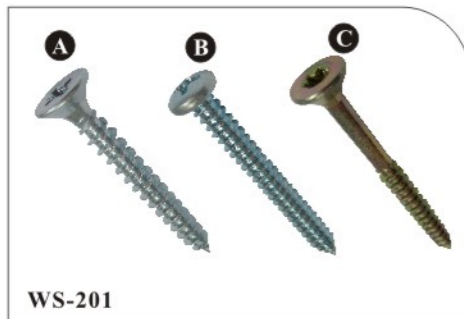

■ **WS-201**
Chipboard Screw

- Material.:Carbon steel, harden
- Size: M2.5--M6
- Surface: Yellow or white zinc-plated, with waxed
- Head Type:
Pozi Contersunk Flat Head
Raised Countersunk Head
Pozi Pan Head

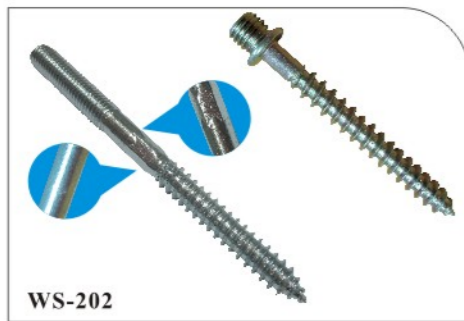

■ **WS-202**
Double Head Screws

- Material.:Mild carbon steel, stainless steel
- Size: M6--M10
- Surface: White zinc plated or yellow zinc plated
- Various sizes are available



■ **WS-203**
Hex Head Wood Screws

- Material.:Carbon steel(4.8, 8.8)
- Surface: White zinc plated or yellow zinc plated
- Size: M4--M20
- Standard: DIN571

■ **WS-204**
DIN95, 96, 97 Slotted Head Wood Screws

- Material.:Carbon Steel
- Surface: White zinc plated or yellow zinc plated
- Size: M2.5--M6
- Head Type:
DIN95: Raised Countersunk Head
DIN96: Round Head
DIN97: Countersunk Head

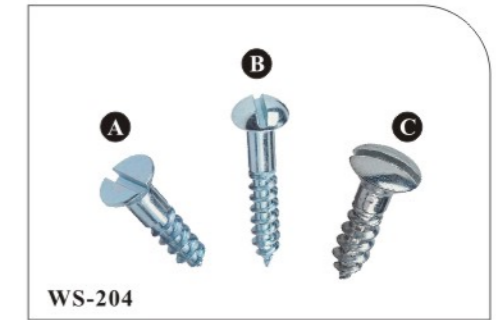

■ **WS-205**
Wood Screws, with Cross Recessed (Pozi) Countersunk Head

- Material.:Carbon steel
- Size: M2.5--M6
- Head style: cross recessed, pozi
- Surface: Yellow zinc-plated or white zinc-plated
- Standard: DIN7997



■ **MS-301**
Machine Screws

- Material.:Carbon Steel, Stainless Steel
- Surface: zinc plated or nickel plated
- Grade: 4.8, 8.8
- Standards: DIN, ANSI
- Size: M2--M10
4#, 5#, 6#, 8#, 10#, 12#, 1/4", 5/16", 3/8"
- Head Type:
A: Slotted Countersunk Head (DIN963)
B: Cross Recessed Countersunk Flat Head (DIN965)
C: Cross Recessed Pan Washer Head (DIN967)
D: Cross Recessed Pan Head (DIN7985)
E: Slotted Cheese Head (DIN84)





MS-302

■ **MS-302**
Screws and Washers Assemblies

- Material.:Carbon steel(8.8), zinc plated
- Size: M2.5--M12
- Standard: DIN6900

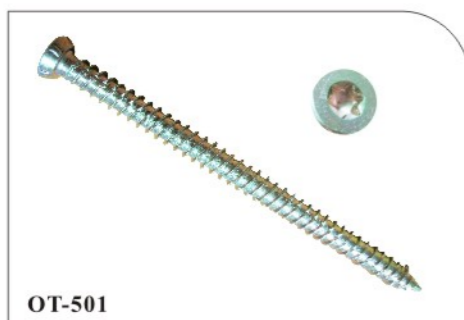

OT-501

■ **OT-501**
Concrete Screws

- Material.:Carbon steel C1022, harden
- Torx csk head: T30, T25
- Surface: Yellow zinc-plated
- Size: 7.5x42 - 7.5x212



OT-502

■ **OT-502**
Confirmat Screws

- Material.:Carbon steel,harden
- White zinc plated
- Size: M5, M7
- Good product performance



BS-601

■ **BS-601**
Threaded Rod

- Material.:Carbon steel(4.8, 8.8), Stainless steel (A2, A4)
- Surface: zinc plated, plain
- Diameter :M6 - M52; 3/16" - 1-1/2"
- Length: 1M, 2M, 3M
- Standard: DIN975, DIN976, ANSI serie

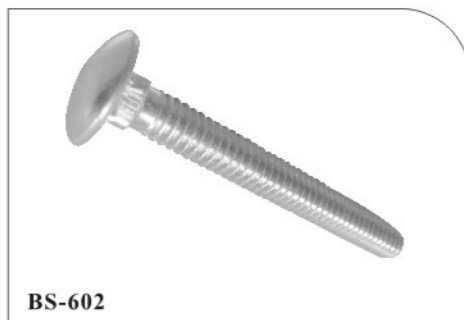

BS-602

■ **BS-602**
Square Shoulder Head Bolts

- Material.:Carbon steel, zinc plated, plain
- Size: M5--M20
- Standards: DIN603
- Finish: zinc plated, plain

■ **BS-603**
Hexagon Head Screws

- Material: Carbon Steel, Stainless steel
- Finish: zinc plated, plain, black
- Standard: DIN931/933/558, ASME.B18.2.1
- Size: M6--M24
1/4"-5/8"



BS-603

■ **BS-604**
Hexagon Flange Bolts

- Material: Carbon Steel, Stainless steel
- Finish: zinc plated, plain, black
- Standard: DIN6921, ASME.B18.2.1
- Size: M5--M20
1/4"-5/8"



BS-604

■ **BS-605**
Wing Screws

- Material: Carbon Steel
- Size: M4--M12
- Standard: DIN316
- Finish: zinc plated, plain, black

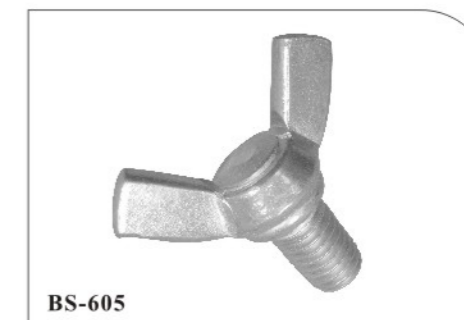

BS-605

■ **NW-001**
Hexagon Nuts

- Material: carbon steel, stainless steel
- Class: 4.8, 8.8, 10.9, 12.9
- Finish: plain, black, zinc-plated
- Standard: DIN934, ANSI-UNC
- Size: M3--M48
3/16" -- 1-1/2"



NW-001

■ **NW-002**
Hexagon Flange Nuts

- Material: Carbon steel, Stainless steel
- Size: M5--M20
- Standard: DIN6923
- Finish: plain, black, zinc-plated



NW-002



NW-003

■ **NW-003**
Wing Nuts

- Material: Carbon steel(4.8, 8.8), zinc plated, plain
- Standard: DIN315, ANSI-UNC
- Size: M4--M24
3/16" -- 1-1/2"



NW-004

■ **NW-004**
Prevailing Torque Type Hexagon Nuts, heavy type, with nylon insert

- Material.:Carbon steel, zinc plated; Stainless steel
- Size: M3--M20
- Standard: DIN985

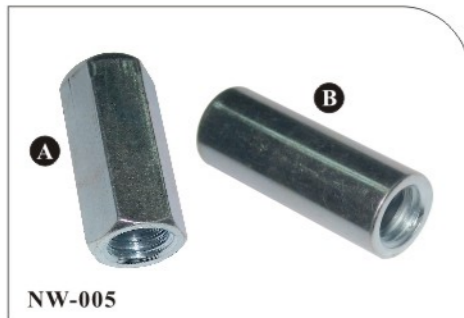

NW-005

■ **NW-005**
Long Nuts

- Material.: Carbon steel, stainless steel
- Surface: zinc plated
- Size: M5--M12

Item	Thread Size	Across Flat (mm)	Length (mm)
Hex Type	M5-P0.8	8	20~25
	M6-P1.0	10	15~50
	M8-P1.25	11	20~50
	M8-P1.25	13	25~50
	M10-P1.5	17	25~50
	M12-P1.75	19	30~50
Round Type	M4-P0.8	7	15~20
	M5-P0.8	8	20~25
	M6-P1.0	10	10~50
	M8-P1.25	11	15~50
	M10-P1.5	13	20~50
	M12-P1.75	15	20~60

■ **NW-006**
Hex Domed Cap Nuts

- Material.:Carbon steel, zinc plated; Stainless steel
- Size: M4--M24
- Standard: DIN1587



NW-006

■ **NW-007**
Flat Washers

- Material: Carbon steel, Stainless steel (A2, A4)
- Surface: zinc plated; plain
- Standard: DIN125A/9021, ASME Series
- Size: M3--M24
3/16" -- 1-1/2"

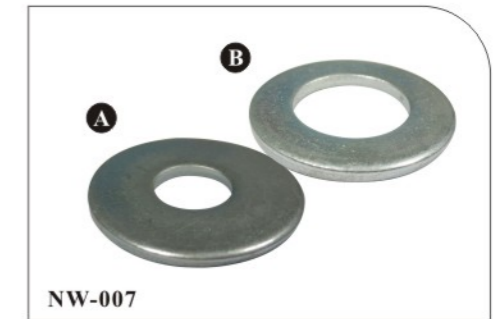

NW-007

■ **NW-008**
Single Coil Lock Washers

- Material: Carbon steel, Stainless steel
- Surface: zinc plated; plain
- Standard: DIN127, ASME Series
- Size: M3--M24
3/16" -- 1-1/2"



NW-008

■ **NW-009**
Teeth Lock Washers

- Material: Carbon steel,Stainless steel
- Surface: zinc plated; plain
- Size: M3--M16
- Standard:
DIN6797A: External
DIN6797J: Internal

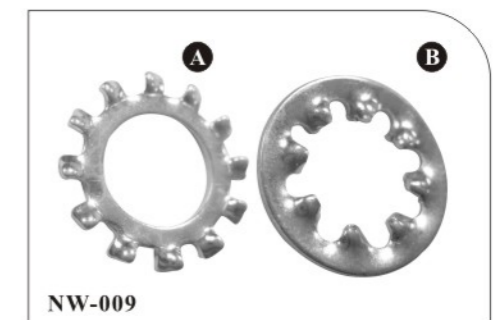

NW-009

■ **NW-010**
Square Nuts Without Bevel

- Material.:Carbon steel, zinc plated; stainless steel
- Size: M3--M10
- Standard: DIN562



NW-010



RH-001

■ **RH-001**
Turnbuckle

- Material.: Carbon steel, stainless steel
- Surface: zinc plated
- Size : M6 -- M36
- Type: Eye + Hook, Eye+Eye, Hook+Hook, Welding ends
- Standard: DIN1480



RH-002

■ **RH-002**
Wire Rope Clip

- Material.: Carbon steel, stainless steel
- Surface: zinc plated
- Size : M3 -- M40
- Standard: DIN 741

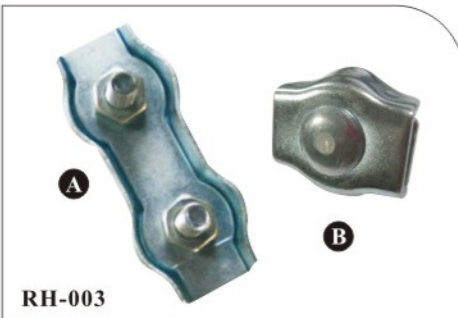

RH-003

■ **RH-003**
Single/Double Wire Rope Clip

- Material.: Carbon steel, stainless steel
- Surface: zinc plated
- Size : M2 -- M10



RH-004

■ **RH-004**
European Type Large Dee Shackle

- Material.: Carbon steel, stainless steel
- Surface: zinc plated
- Size : M3.5 -- M25

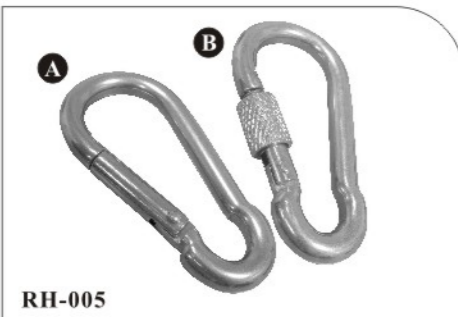

RH-005

■ **RH-005**
Snap Hook

- Material.: Carbon steel, stainless steel
- Surface: zinc plated
- Size : M4 -- M15
- Standard: DIN 5299C, DIN5299D

■ **RH-006**
Timble, European type

- Material.: Carbon steel, stainless steel
- Surface: zinc plated
- Size : M3 -- M26
- Standard: DIN 6899B



RH-006

■ **RH-007**
Eye Bolt / Nut

- Material.: Carbon steel, stainless steel
- Surface: zinc plated
- Size : M6 -- M30
- Standard: DIN 580/DIN582

- **A** DIN582
- **B** DIN580

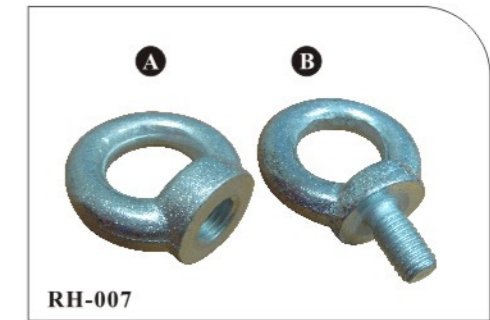

RH-007

■ **RH-008**
Quick Link

- Material.: Carbon steel, stainless steel
- Surface: zinc plated
- Size : M3.5 -- M16



RH-008

■ **RH-009**
"S" Light Hook

- Material.: Carbon steel, stainless steel
- Surface: zinc plated
- Size : M3 -- M12

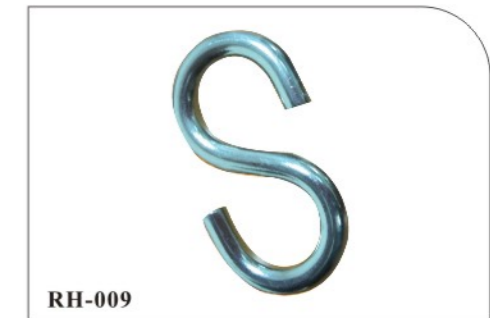

RH-009

■ **RH-010**
Repair Link

- Material.: Carbon steel, stainless steel
- Surface: zinc plated
- Size : M3 -- M10



RH-010

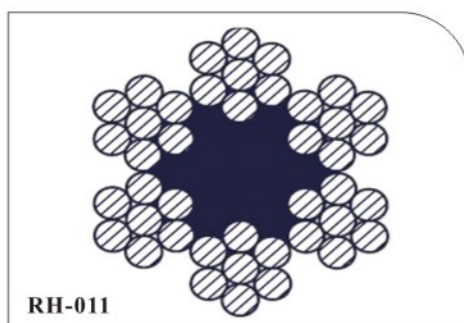

■ **RH-011**
Steel Wire Rope

- Material.: Carbon steel, stainless steel
- Surface: zinc plated
- Size : M1 -- M10
- Standard: DIN3055
- Packing: wooden/plastic reel

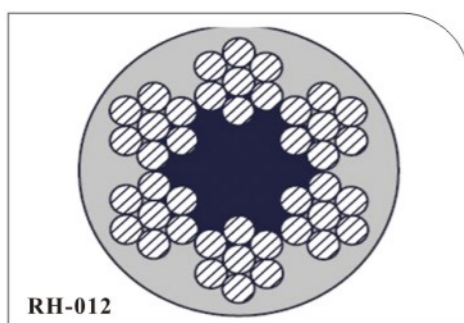

■ **RH-012**
Steel Wire Rope, in PVC

- Material.: Carbon steel, stainless steel
- Surface: zinc plated
- Size : M2/3 -- M8/10
- Standard: DIN3055
- Packing: wooden/plastic reel

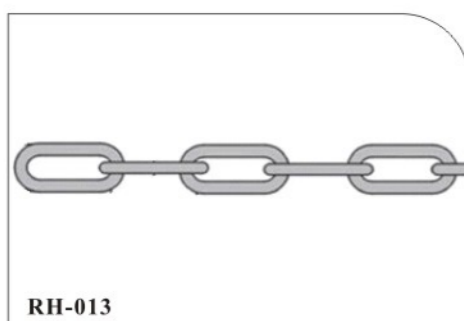

■ **RH-013**
Link Chain

- Material.: Carbon steel, stainless steel
- Surface: zinc plated
- Size : M1.5 -- M10
- Standard: DIN763
- Packing: wooden/plastic reel, gunny bag

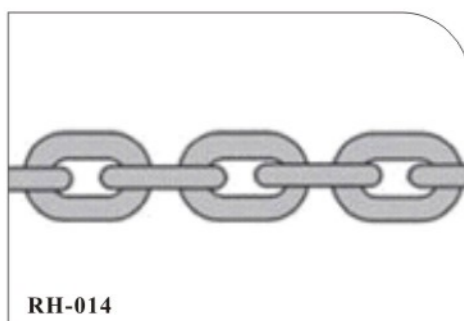

■ **RH-014**
Link Chain

- Material.: Carbon steel, stainless steel
- Surface: zinc plated
- Size : M1.5 -- M10
- Standard: DIN766
- Packing: wooden/plastic reel, gunny bag

Packages:

Blister packing --- Double Blisters, Clamshells, Carded Blisters
Sealed by staples or plastic-injection machine.



Cardboard Box --- Various and Customized designs available.



Plastic Bag --- Various and Customized designs available.



Plastic Bag --- Various and Customized designs available.



Outer packing--- Various and Customized designs available.



Quality Control

Quality control

Equipped with Standard and Authoritative Inspection facilities of fasteners, to ensure high quality productions.

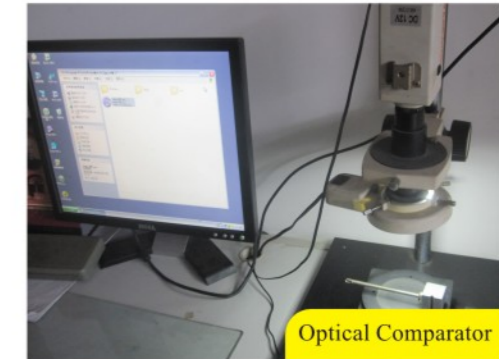

Optical Comparator



Salt Spray Tester



Drilling Speed Tester for Screws



GO/NOGO Gauge for nuts



GO&NOGO Gauge for Thread Rod